

EWF10744  
EWF12844

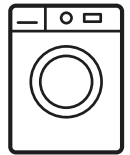

---

EN Washing Machine

---

User Manual

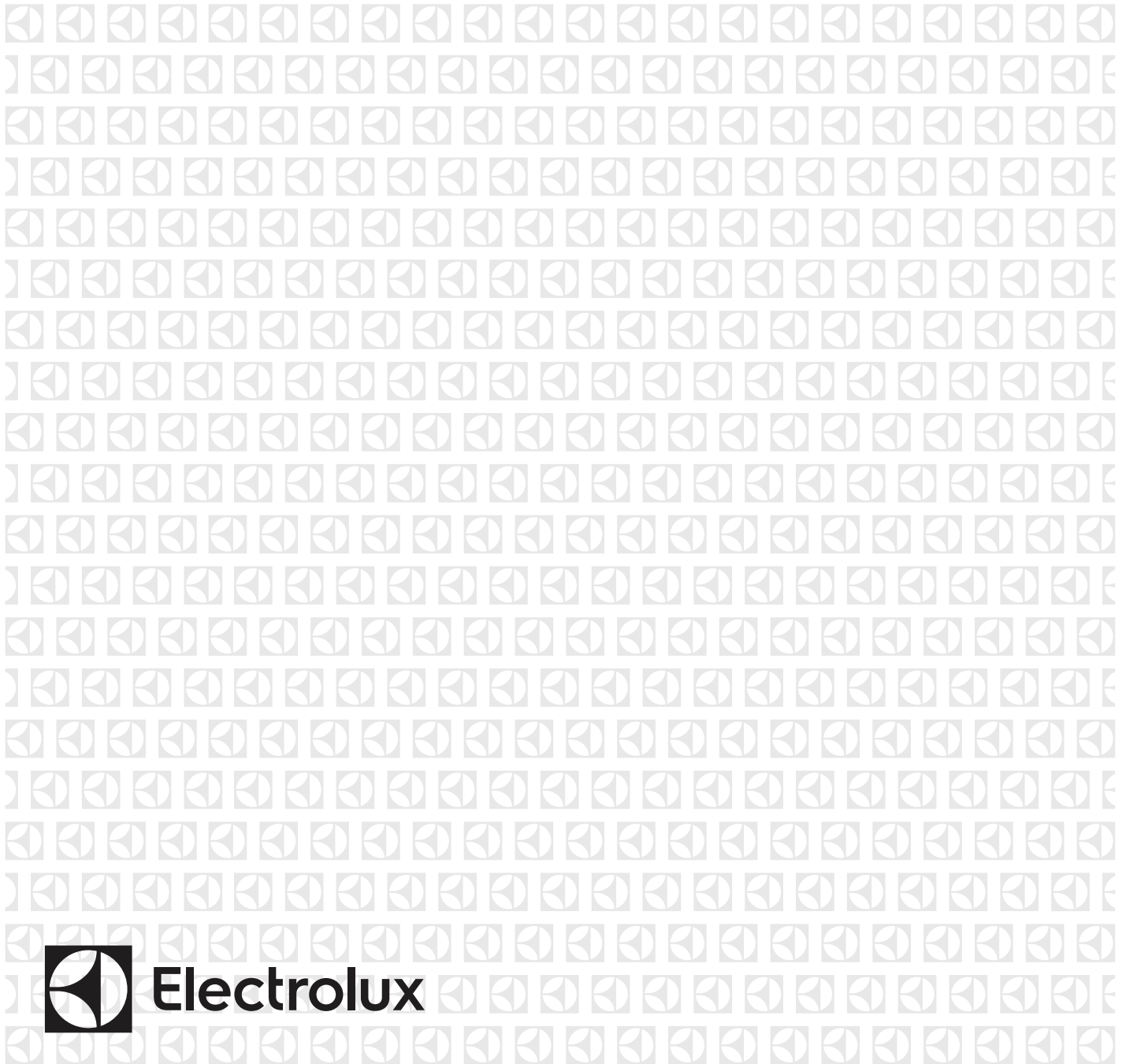

**Electrolux**

# CONTENTS

1	SAFETY INFORMATION .....	3
2	PRODUCT DESCRIPTION .....	6
3	CONTROL PANEL .....	7
4	BEFORE FIRST USE .....	12
5	DAILY USE .....	13
6	WASHING HINTS .....	18
7	INTERNATIONAL WASH CODE SYMBOLS .....	21
8	CARE AND CLEANING .....	22
9	TROUBLESHOOTING .....	25
10	TECHNICAL DATA .....	28
11	INSTALLATION .....	28
12	ENVIRONMENT CONCERNS .....	33

---

## WE'RE THINKING OF YOU

Thank you for purchasing an Electrolux appliance. You've chosen a product that brings with it decades of professional experience and innovation. Ingenious and stylish, it has been designed with you in mind. So whenever you use it, you can be safe in the knowledge that you'll get great results every time. Welcome to Electrolux.

### Visit our website to:





Get usage advice, brochures, trouble shooter, service information:  
**www.electrolux.com**

---

## CUSTOMER CARE AND SERVICE

We recommend the use of original spare parts.  
When contacting Service, ensure that you have the following data available.  
The information can be found on the rating plate. Model, PNC, Serial Number.

-  Warning / Caution-Safety information.
-  General information and tips.
-  Environmental information.

**Subject to change without notice.**

<b>RoHS</b> Compliant	<b>Being ensured permissible content limitation of some toxic chemicals (RoHS compliant)</b>
--------------------------	--

# 1. SAFETY INFORMATION

## CONDITIONS OF USE

This appliance is intended to be used in household and similar applications such as:

- Farm houses
- By clients in serviced apartments, holiday apartments and residential type environments.

In the interest of your safety and to ensure the correct use, before installing and first using the appliance, read this user manual carefully, including its hints and warnings.

To avoid unnecessary mistakes and accidents, it is important to ensure that all people using the appliance are thoroughly familiar with its operation and safety features.

Save these instructions and make sure that they remain with the appliance if it is moved or sold, so that everyone using it through its life will be properly informed on appliance use and safety.

### 1.1 GENERAL SAFETY



It is dangerous to alter the specifications or attempt to modify this product in anyway.



During high temperature wash program the door glass may get hot. Do not touch it!



Make sure that small pets do not climb into the drum. To avoid this, please check into the drum before using the appliance.



Any objects such as coins, safety pins, nails, screws, stones or any other hard, sharp material can cause extensive damage and must not be placed into the machine.



Wash small items such as socks, laces, washable belts etc in a washing bag or pillow case as it is possible for such items to slip down between the tub and the inner drum.



Only use the advised quantities of fabric softener and detergent. Damage to the fabric or appliance can occur if you overfill. Refer to the manufacturer's recommendations of quantities.



This appliance is not intended for use by persons (including children) with reduced physical, sensory or mental capabilities, or lack of experience and knowledge, unless they have been given supervision or instruction concerning use of the appliance by a person responsible for their safety.



Do not use your washing machine to wash articles with whalebones, material without hems or torn material.



Always unplug the appliance and turn off the water supply after use, clean and maintenance.



Under no circumstances should you attempt to repair the machine yourself. Repairs carried out by inexperienced persons may cause injury or serious malfunctioning. Contact your local Service Centre. Always insist on genuine spare parts.

---

## 1.2 INSTALLATION



This appliance is heavy. Care should be taken when moving it.



When unpacking the appliance, check that it is not damaged. If in doubt, do not use it and contact the Service Centre.



After having installed the appliance, check that it is not standing on the inlet and drain hose and the worktop is not pressing the electrical supply cable.



If the machine is situated on a carpeted floor, please adjust the feet in order to allow air to circulate freely.



All packing and transit bolts must be removed before use. Serious damage can occur to the product and to property if this is not adhered to. See relevant section in the user manual.



Always be sure, that there is no water leakage from hoses and their connections after the installation.









Any plumbing work required to install this appliance should be carried out by a qualified plumber.









Any electrical work required to install this appliance should be carried out by a qualified electrician.

---

### 1.3 USE

-  This appliance is designed for domestic use. It must not be used for purposes other than those for which it was designed.
-  Only wash fabrics which are designed to be machine washed. Follow the instructions on each garment label.
-  Do not overload the appliance. See the relevant section in the user manual.
-  Before washing, ensure that all pockets are empty and buttons and zips are fastened. Avoid washing frayed or torn articles and treat stains such as paint, ink, rust, and grass before washing. Underwired bras must NOT be machine washed.
-  Garments which have been in contact with volatile petroleum products should not be machine washed. If volatile cleaning fluids are used, care should be taken to ensure that the fluid is removed from the garment before placing in the machine.
-  Never pull the power supply cable to remove the plug from the socket; always take hold of the plug itself.
-  Never use the washing machine if the power supply cable, the control panel, the working surface or the base are damaged so that the inside of the washing machine is accessible.

### 1.4 CHILD SAFETY

-  This washing machine is not intended for use by young children or infirm persons without supervision.
-  Young children should be supervised to ensure that they do not play with the appliance.
-  The packaging components (e.g. plastic film, polystyrene) can be dangerous to children - danger of suffocation! Keep them out of children's reach.
-  Keep all detergents in a safe place out of children's reach.
-  Make sure that children or pets do not climb into the drum.
-  This machine is provided child lock option (  ) to prevent the children play with the control panel. (see page 10)

## 2. PRODUCT DESCRIPTION

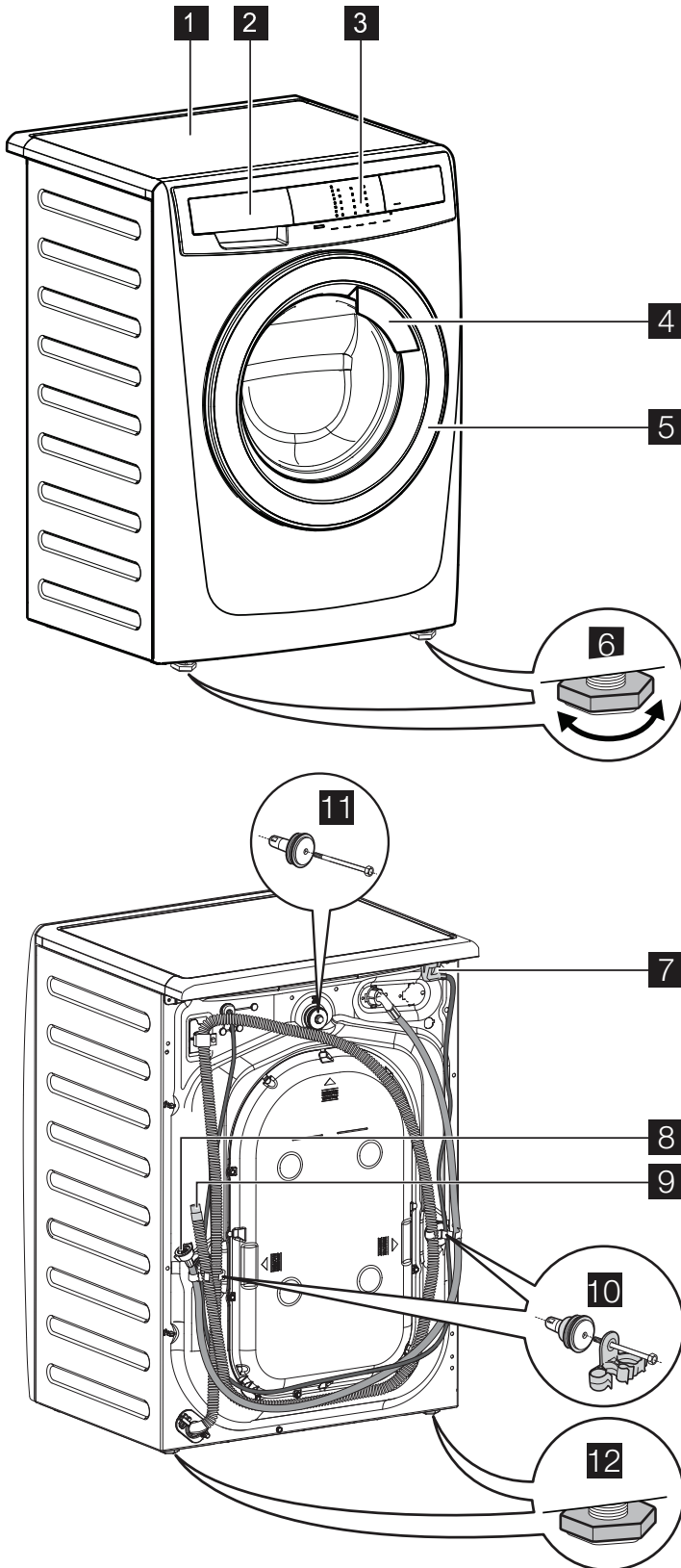

- 1 Worktop
- 2 Detergent/Softener Dispenser
- 3 Control Panel
- 4 Door Handle
- 5 Door

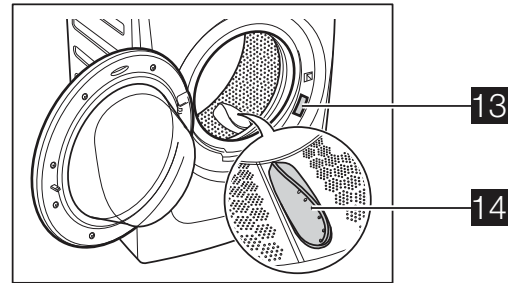

- 6 Level Adjustment Feet (Front)
- 7 Mains Cable
- 8 Water Inlet Hose
- 9 Water Drain Hose
- 10 Hose Support + Transit Bolts
- 11 Transit Bolts
- 12 Back Feet (Fixed)
- 13 Rating Label
- 14 Drum Leaf Lifter

### ACCESSORIES

- **Plastic caps**



To close the holes on the rear side of the cabinet after the removal of the transit bolts.

- **Plastic hose guide**



To connect the drain hose on the edge of a sink.



\* This machine is integrated drain design; lint will be drained out and don't need to clean the filter regularly. **If you would like to clean the filter, please contact your local Service Center.**

## 3. CONTROL PANEL

### 3.1 Control Panel Description

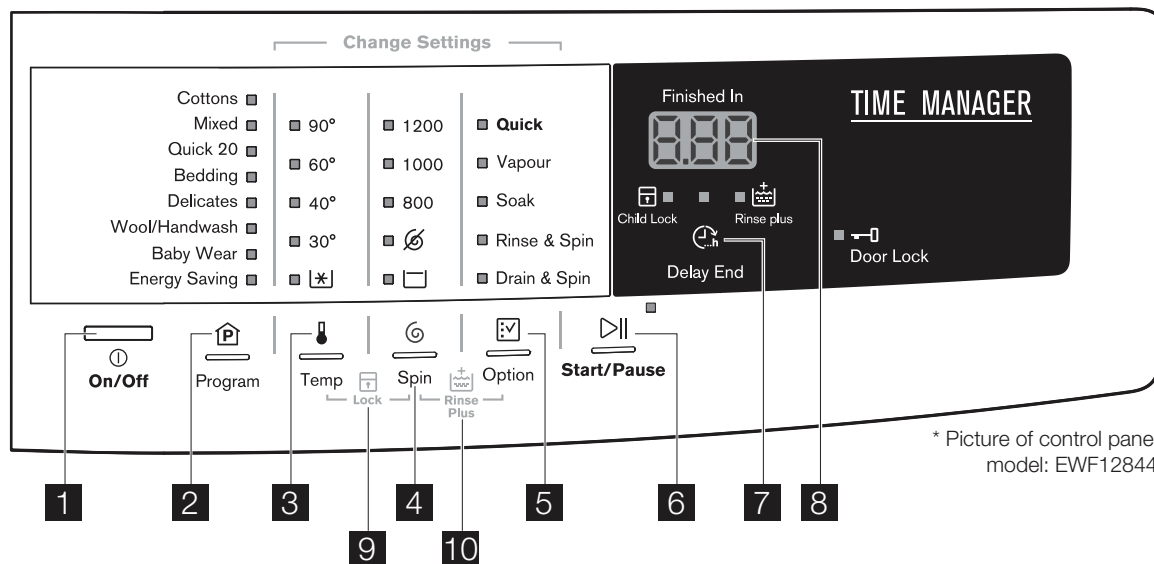

\* Picture of control panel model: EWF12844

#### 1 On/Off Button ( ⏻ )

On/Off button is used to turn on and turn off your washing machine.

#### 2 Program Touchpads ( 🏠 )

Press this touchpad to select the washing program. The relevant light will light up. (For more information about washing program, please see on page 11-12)

#### 3 Temperature Touchpad ( 🌡 )

Press this touchpad repeatedly to increase or decrease the wash temperature if you want your laundry to be washed at a temperature different from the one proposed by the washing machine. The relevant light will light up.

**i** Different temperatures can be combined which is dependent on the program selected.

**i** **During a high temperature cycle you may notice vapour exiting from the detergent dispenser drawer of the washing machine, this is normal and there is no cause for alarm.**

#### 4 Spin Touchpad ( 🌀 )

Press this touchpad repeatedly to increase or decrease the spin speed, if you want your laundry to be spun at a speed different from the one proposed by the washing machine. The relevant light will light up.

**i** Different spin speed can be combined which is dependent on the program selected.

#### 🌀 No Spin

This option eliminates all the spin phases and adds 3 rinses to the Cottons program and 1 rinse for another programs.

#### 📄 Rinse Hold

By selecting this option the water of the last rinse is not emptied out and the drum turns regularly to prevent the laundry creases. The door is still locked to indicate that the water must be emptied out.

**i** The door stays locked with the water in the drum. To drain the water refer to relevant paragraph on page 17.

#### 5 Option Touchpad ( 📄 )

Press the option touchpad, if you want your laundry to be washed with special functions. The relevant light will light up.



**i** Different options can be combined which is dependent on the program selected.

- **Quick**

With this option you can decrease the program duration. Use this option for items with light soil or items to refresh.

**i** This option will reduce the working time and the number of rinses.

If you need to add more rinse phases, press “⊗” + “☑” at the same time to add “Rinse Plus” option. (see page 10)

- **Vapour**

Select this option to add approximately 30 - 45 minutes of tumbling in vapour during the wash cycle. Vapour helps open fabric fibers up to allow laundry additives to release tough stains. The indicator of this option comes on.

**i NOTE:**

- Vapour may not necessarily be visible inside the drum during a vapour wash cycle. Vapour is created below the drum and allowed to naturally rise into the clothes.
- Vapour may not be present during the entire vapour wash cycle.
- Vapour function is more effective with half load.
- At the end of the Vapour cycle the clothes will be warmer, softer and detached from the drum.
- If Vapour option is selected, rinse temperatures will be elevated.
- During a vapour cycle you may notice vapour exiting from the drain hose of the washing machine, this is normal and there is no cause for alarm.

- **Soak**

This option allows you to soak heavily soiled clothes and stained items at the beginning of the wash before main washing phase.

This option will increase the duration of the program selected for about 50 minutes. And uses more water from normal wash. The process is as follows.

**(1) fill water and turn the washing drum** (this takes about 20 minutes)

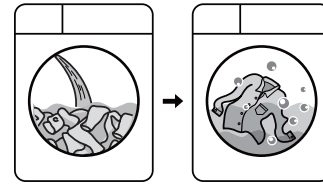

After press Start/Pause touchpad, the machine will start add water to the washing drum, which will start to rotate slowly to dissolve detergent and evenly distribute cloths.

**(2) soak** (this takes about 30 minutes.)

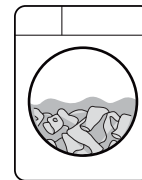

The machine will enter the process of soaking, The washing drum will stop and rotate once in a while in order to redistribute cloths.

**(3)** Once the soak process complete, the machine will check the water level again and will start the selected program and continue **by using the same soak water.**

If you **Do not** wish to use the soak water to wash cloth, please follow the steps below:

1. Press Start/Pause to pause the washing machine. Then press ON/OFF to turn off the machine.
2. Press ON/OFF again to start the machine, add detergent, and select the program of your choice. Press Start/Pause again to start the selected program. The machine will detect and drain the water in the washing drum out automatically and fill in water once again to be used for washing.





**i** Any temperature may be selected, but **COLD** (  ) water is recommended with this cycle as hotter water may set some stains.

Use the amount of detergent recommended for a normal wash cycle. If desired, use a bleach or a soaking agent safe for the fabric, by pouring it into the detergent compartment.

#### • Rinse & Spin

With this option you can perform only a last rinse of a selected washing program.

If you set also the Rinse Plus function (  ) the appliance adds two rinses.

If you set also the “No Spin ” option, the appliance only rinse.

#### • Drain & Spin

Use this option for very wet clothes to remove the water and spin.

If you set also the “No Spin ” option, the appliance only drains.

### 6 Start/Pause Touchpad ( )

To start the selected program, press the “Start/Pause (  )”.

To interrupt a program which is running, press the “Start/Pause (  )” to pause the machine, the Start/Pause pilot light flashes.

To restart the program from the point at which it was interrupted, press the “Start/Pause (  )” again, the Start/Pause pilot light will stop flashing.

### 7 Delay End Touchpad ( )

Before you start the program, this option makes it possible to define the end of the washing program from minimum 3 hours to maximum 20 hours.

#### **i** NOTE:

If program duration is longer than 3 hours minimum Delay End option starts from 4 hours.

Press the Delay End touchpad to choose the end time as your wish. The display shows the number of hours and the indicator above the touchpad is on. This option must be selected after choosing the wash program, and before pressing the “Start/Pause” touchpad. For example, if the program duration of your selected program is 3.20 hours and you define the “Delay End” time to 6 hours. This means your wash program will finish in 6 hours. (See diagram)

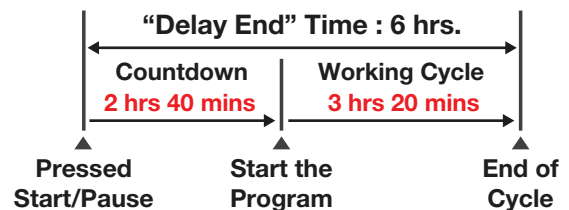

After select Delay End time, press Start/Pause touchpad to start the program. Machine will then countdown and update time on the display every hours until it reaches the starting point of the wash cycle.

If you wish to modify or cancel Delay End option after starting the program, follow the steps below:

- set the washing machine to PAUSE by pressing “Start/Pause” touchpad;
- deselect this option by pressing Delay End once;
- press the “Start/Pause” to start the program.

### 8 Display

The display shows the following information:

#### Estimated time of the selected program



After selecting a program, the estimated time is displayed in hours and minutes (for example 3.01). The estimated time is calculated automatically on the basis of the maximum recommended load for each type of fabric.

After the program has started, the time remaining is updated every minute.

### End Of Program



When the program is completed the display will show “0”.

### Alarm Codes



In the event of operating problems, some alarm codes can be displayed, for example E20. (see “Troubleshooting”)

### Incorrect Option Selection



If an option which is not compatible with the set wash program selected, the display will show “Err” and flash with 3 consecutive short beeps.

## 9 Child Lock Option (🔒)

Your appliance is provided with CHILD SAFETY LOCK which permits you to leave the appliance unsupervised with the door closed without having to worry that children might be injured by or cause damage to the appliance. Set this option after pressing the Start/Pause touchpad.

To set “Child Lock” option:

- Press and hold “🔒” and “🌀” touchpads at the same time until the LED “🔒” lights up.

**i** **The touchpads are locked (except for the On/Off “🔒” button).**

- To deactivate press and hold these 2 touchpads at the same time until the LED “🔒” goes off.

**i** This function remains enabled even after the appliance is switched off.

## 10 Rinse Plus Option (🚰)

Select this option to add 2 rinses to a program.

This option is recommended for people who are allergic to detergents, and in areas where the water is very soft.

**i** **This function increases the program duration.**

To set “Rinse Plus” option:

- Press and hold “🌀” and “🚰” touchpads at the same time until the LED “🚰” lights up.
- To deactivate press and hold these 2 touchpads at the same time until the LED “🚰” goes off.

**i** **This function remains enabled even after the appliance is switched off.**

## 3.2 Enabling/Disabling Buzzer Sounds





The buzzer sounds operate when:

- The program is completed.
- The appliance has a malfunction.

• If you want to disable the buzzer sound (except for event of appliance malfunction), press and hold “Programs 🏠” and “Temp 🔒” touchpads at the same time for 3 seconds, and listen for “BEEP, BEEP”.

• To enable the Buzzer press and hold these 2 touchpads at the same time for 3 seconds, and listen for “BEEP”.

### 3.3 Programs + Options

Program; Temp.	Program Description (type of load and soil level)	Maximum Dry Clothes Capacity (Model: Max. kg)	Maximum Spin Speed (Model: Max. RPM)	Options								
				No Spin	Rinse Hold	Quick	Vapour <sup>1)</sup>	Soak	Rinse & Spin	Drain & Spin	Delay End	Rinse +
<b>Cottons;</b> Cold (  ) to 90 °C	White and coloured cotton with heavy level of soil.	EWF12844: 8 kg	EWF12844: 1200 RPM	■	■	■	■	■	■	■	■	■
		EWF10744: 7.5 kg	EWF10744: 1000 RPM									
<b>Mixed;</b> Cold (  ) to 60 °C	Synthetic or mixed fabric items with normal level of soil.	EWF12844: 4 kg	EWF12844: 1200 RPM	■	■	■	■	■	■	■	■	■
		EWF10744: 3.5 kg	EWF10744: 1000 RPM									
<b>Quick 20;</b> 30 °C	Synthetic and mixed fabric items. Light soil and items to freshen up.	EWF12844: 1.5 kg	EWF12844, EWF10744: 800 RPM	■	■				■	■	■	
		EWF10744: 1 kg										
<b>Bedding;</b> Cold (  ) to 40 °C	Special program for one synthetic blanket, duvet, bedspread and so on.	EWF12844: 4 kg	EWF12844, EWF10744: 800 RPM	■	■		■	■	■	■	■	■
		EWF10744: 3.5 kg										
<b>Delicates;</b> Cold (  ) to 40 °C	Delicate fabrics as acrylics, viscose, polyester items with normal soil.	EWF12844: 4 kg	EWF12844: 1200 RPM	■	■	■	■	■	■	■	■	■
		EWF10744: 3.5 kg	EWF10744: 1000 RPM									
<b>Wool/ Handwash;</b> Cold (  ) to 40 °C	Specially tested program for woollen garments bearing the “Pure new woollen, non-shrink, machine washable” label and hand washing fabrics.	EWF12844, EWF10744: 2.5 kg	EWF12844, EWF10744: 1000 RPM	■	■				■	■	■	

Program; Temp.	Program Description (type of load and soil level)	Maximum Dry Clothes Capacity (Model: Max. kg)	Maximum Spin Speed (Model: Max. RPM)	Options								
				No Spin	Rinse Hold	Quick	Vapour <sup>1)</sup>	Soak	Rinse & Spin	Drain & Spin	Delay End	Rinse +
<b>Baby Wear;</b>  Cold (  ) to 40 °C	Baby cotton clothes and delicate knitting items with normal soil;	EWF12844: 4 kg	EWF12844: 1200 RPM	■	■		■	■	■	■	■	■
		EWF10744: 3.5 kg	EWF10744: 1000 RPM									
<b>Energy Saving;</b>  40 °C and 60 °C <sup>2)</sup>	White and colourfast, cotton with normal soil. Set this program to have a good washing results and decrease the energy consump- tion. The time of the washing program is extended;	EWF12844: 8 kg	EWF12844: 1200 RPM									
		EWF10744: 7.5 kg	EWF10744: 1000 RPM	■	■	■	■	■	■	■	■	■

1) Vapour option can be combined with temperature 40 to 90 °C only.

2) "Energy Saving" program with 60 °C option selected is recommended for a full load of normally soiled cottons.

## 4. BEFORE FIRST USE

1. Ensure that the electrical and water connections comply with the installation instructions.
2. Put 2 litres of water in the detergent compartment for washing phase. This activates the drain system.
3. Select "Cottons" cycle at 90 °C, without any laundry in the machine, to remove any manufacturing residue from the drum and tub then start the machine.

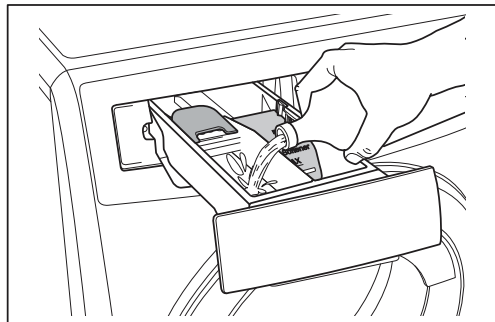

# 5. DAILY USE

- Connect the mains plug to the mains socket.
- Turn the water tap on.

## 5.1 Four Steps Start Up Guide

### **Step 1** - Loading The Laundry

1. **i IMPORTANT!**

- Make sure that no metal objects are left in the laundry (e.g. hair clips, safety pins, pins).
- Make sure that you wash lint collectors separately from lint producers.
- Button up pillowcases, close zip fasteners, hooks and poppers. Tie any belts or long tapes.

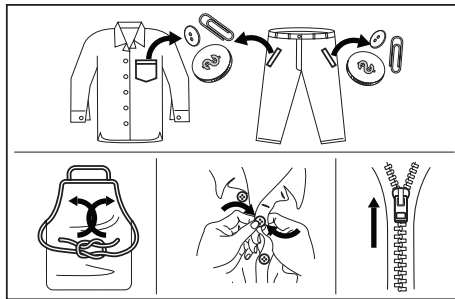

- Wash bras, pantyhose and other delicates in a mesh laundry bag, which you can purchase from your supermarket.

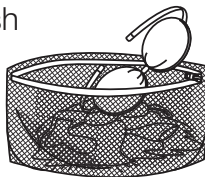

2. Open the door by carefully pulling the door handle outwards.

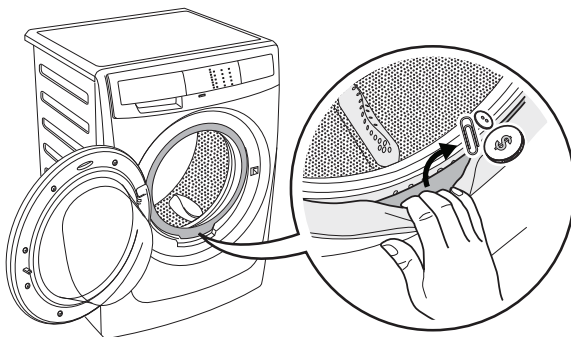

Check and remove objects (if there are any) that could be trapped in the fold.

3. Place the laundry in the drum, one item at a time, shaking them out as much as possible.

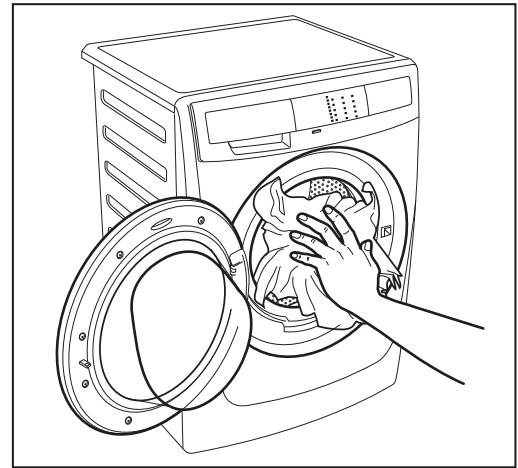

4. Close the door and make sure that no laundry remains between the seal and the door. There is a risk of water leakage or damage to the machine and your laundry.

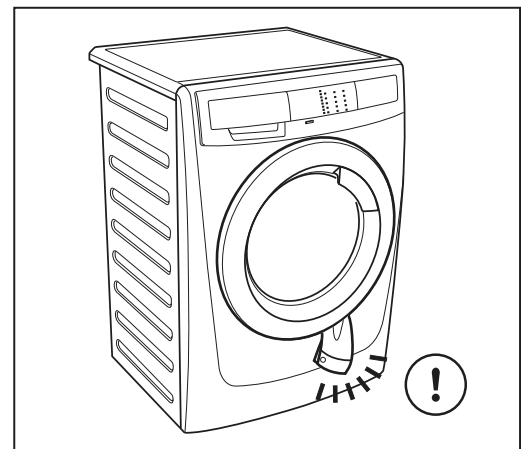

## Step 2 - Using Detergent And Additives

**i** **IMPORTANT:** Please read the detergents instructions on page 20 before use.

### 1. Detergent Dispenser Drawer

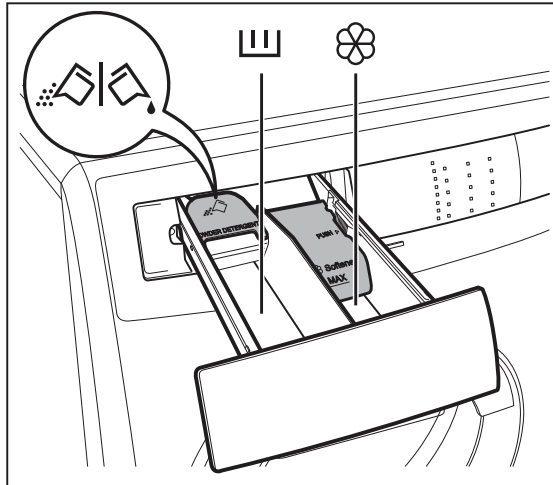



The detergent dispenser is divided into two compartments.

-  **Compartment "DETERGENT"**  
This compartment is used for detergent on all programs.
-  **Compartment "SOFTENER"**  
This compartment is used for fabric conditioner and starching agent.

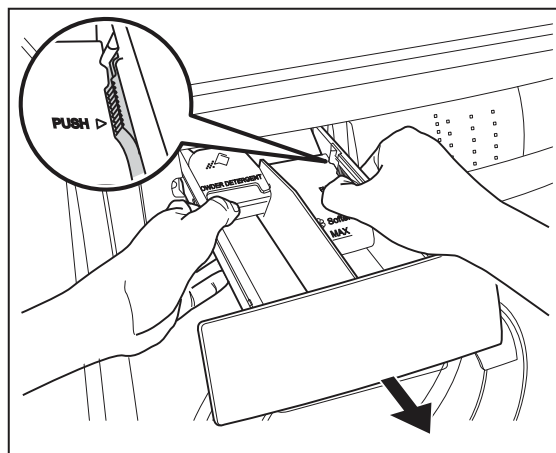
### Powder or liquid detergent ( )



-  Position **up**: for powder detergent (factory setting).
-  Position **down**: for liquid detergent.

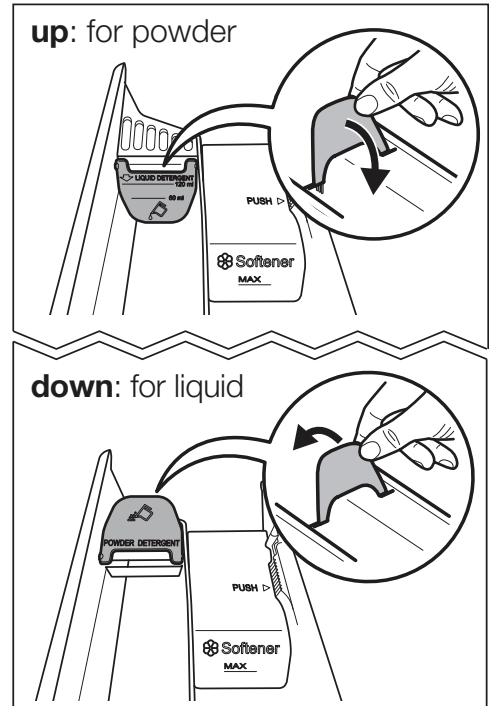

**i** **When you use the liquid detergent:**

- Do not use gelatinous or thick liquid detergents.
  - Do not put more liquid than the maximum level.
  - Do not set the DELAY END.
2. Measure out the detergent and the fabric softener;
- Pull out the dispenser drawer until it stops.
  - Measure out the amount of detergent required, pour it into the main wash compartment (  ).

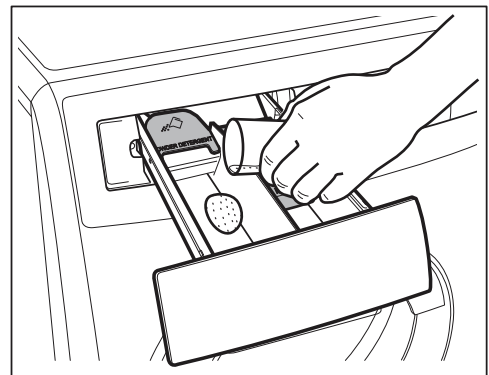



- If required, pour fabric softener into the compartment marked  (the amount used must not exceed the "MAX" mark in the drawer).

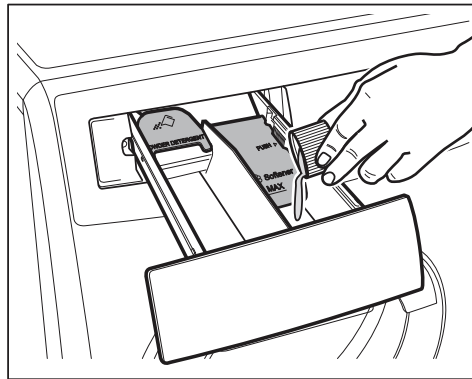



- Close the drawer gently.

**i** If you use thick softeners it is recommended to dilute with water.

**i** After washing cycle finish, residues of detergent, softener and water may remain in the dispenser. It is recommended to clean the dispenser regularly to remove any residue.

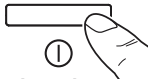
### Step 3 - Setting A Program For Washing



1.  Press the On/Off button to turn on the washing machine. The indicator of the "Start/Pause" touchpad flashes.

2.  Press the Program touchpad, to choose the wash program you require. (For more information about washing programs, please see page 11-12)

- Cottons
- Mixed
- Quick 20
- Bedding
- Delicates
- Wool/Handwash
- Baby Wear
- Energy Saving

- The relevant light will light up.
- The display shows the program duration.

3. 

<input type="checkbox"/> 90°	<input type="checkbox"/> 1200	If you want your laundry to be spun or use temperature different from the one proposed by the washing machine.
<input type="checkbox"/> 60°	<input type="checkbox"/> 1000	
<input type="checkbox"/> 40°	<input type="checkbox"/> 800	
<input type="checkbox"/> 30°	<input type="checkbox"/> 	
<input type="checkbox"/> 	<input type="checkbox"/> 	



Press the Spin "G" and the temperature "⌵" touchpads repeatedly to change the spin speed and temperature.

4. 

<input type="checkbox"/> Quick	Press this touchpad, if you want your laundry to be washed with special functions. The relevant light will light up.
<input type="checkbox"/> Vapour	
<input type="checkbox"/> Soak	
<input type="checkbox"/> Rinse & Spin	
<input type="checkbox"/> Drain & Spin	



**i** Different functions can be combined which is dependent on the program selected.

**i** If you want to reduce washing time, select the **Quick**\* option to reduce washing time.

(\* this option suitable for light soil items or items need to refresh)

5. If you want to define the end of the washing program, press the "Delay End (⌵)" touchpad repeatedly to choose your washing machine working time.



## Step 4 - Starting a program



To start a program, press the Start/Pause (▶||) touchpad, the corresponding pilot light will stop flashing and a default program duration will be displayed on the screen.

### **i** NOTE

After starting the washing program the dot (•) on the display starts to flash. The appliance will automatically adjust the selected program duration according to the type and size of the load (approximately 15 minutes). When this phase ends the dot (•) lights up fixed and the display will show adjusted program duration.



## 5.2 Interruption Of A Program

- To pause press Start/Pause. The indicator will start flashing.
- Press the Start/Pause again. The program will continue.

## 5.3 Changing A Program

Changing a running program is possible only by switching off the appliance.

- Press the “On/Off” button to cancel the program and to turn off the appliance.
- Press the “On/Off” button again to start the appliance. Now, you can set a new washing program.

**i** The appliance will not drain the water.

## 5.4 Changing The Options

**i** It is possible to change only some option after the program has started.

1. Press the touchpad Start/Pause. The indicator will start flashing.
2. Change the options.
3. Press Start/Pause again. The program will continue.

## 5.5 Opening The Door

While a program or the Delay End is operating, the appliance door is locked and the door lock indicator “” is on.

First set the machine to PAUSE by pressing the “Start/Pause” touchpad. Wait until the door lock indicator “” goes off, then the door can be opened.

If the door lock indicator “” does not disappear, **this means that the machine is already heating and the water level is above the bottom edge of the door or the drum is turning.** In this case the door CAN NOT be opened. If you need to open it, you must drain the water to open the door.

To drain the water, you have to switch the machine off by pressing the “On/Off” button to deactivate the appliance. Turn On the machine and select “Drain & Spin” option, then press Start/Pause touchpad to start the program.

**i** You can select “**No Spin** ”, if you want the machine to only drain the water.

When the program is completed and the door lock indicator “” goes off, you can open the door.



## 5.6 When The Washing Program Is Completed, But There Is Water In The Drum (Option “Rinse Hold ” is used)

- The drum turns regularly to prevent the creases in the laundry.
- The indicator “Start/Pause” flashes to remind you to drain the water.
- The door lock indicator “” is on. The door stays locked.

You must drain the water to open the door.

### To drain the water:

1. Press the “Start/Pause ” touchpad. The appliance drains the water and spins with the maximum spin speed for selected program.



**Alternatively**, before pressing the “Start/Pause” touchpad, you can press the “Spin ” touchpad to change the spin speed. You can select “No Spin ”, if you want the machine to only drain the water, then press the Start/Pause touchpad. The appliance will drain the water and spin.

2. When the program is completed and the door lock indicator “” goes off, you can open the door.
3. Press the “On/Off” button to deactivate the appliance.



After approximately 18 hours if you do not press Start/Pause touchpad, the appliance will drain and spin automatically (except for Wool/Handwash program) .

## 5.7 At The End Of The Program

- The appliance stops automatically.
- The acoustic signal will operate.
- The display will show “”.
- The indicator of the “Start/Pause” touchpad goes off.
- The door lock indicator “” goes off.
- Remove the laundry from the appliance. Make sure that the drum is empty.
- Keep the door and the detergent drawer ajar, to prevent the mildew and odours.
- Turn off the water tap.



### NOTE

**At the end of the program the time remaining can suddenly decrease from 7 minutes or less to 0 due to the overestimated total program time during the load sensing phase.**

**In some cases (with perfectly balanced load) the program time can be shorter than the time estimated after the load sensing phase is completed. This is a normal behavior of the machine and not a cause for concern as it does not compromise its performance.**

## 5.8 Auto Off Function

The Auto Off Function automatically deactivates the appliance to decrease the energy consumption when:

- You do not press any touchpads for 5 minutes before you press "Start/Pause".

 Press the "On/Off" button to activate the appliance again.

- After 5 minutes from the end of the washing program.



- Press the "On/Off" button to activate the appliance again.
- The display shows the end of the last set program.
- Touch any touchpad the display shows the last setup program and option.
- Touch the program pad again to set a new cycle.

## 6. WASHING HINTS

### 6.1 Sorting The Laundry

Follow the wash code symbols on each garment label and the manufacturer's washing instructions. Sort the laundry as follows: whites, coloureds, synthetics, delicates, woollens.

### 6.2 Temperatures

90°C	For heavily or normally soiled white cottons and linen (e.g. teacloths, towels, tablecloths, sheets...).
60°C 50°C	For normally soiled, colourfast garments (e.g. shirts, night dresses, pyjamas...) in linen, cotton or synthetic fibres and for lightly soiled white cotton (e.g. underwear).
40°C 30°C Cold	For delicate items (e.g. net curtains), mixed laundry including synthetic fibres and woollens bearing the label pure new wool, machine washable, non-shrink.

### 6.3 Before Loading The Laundry

Never wash whites and coloureds together. Whites may lose their "whiteness" in the wash.

New coloured items may run in the first wash; they should therefore be washed separately the first time.

Make sure that no metal objects are left in the laundry (e.g. hair clips, safety pins, pins).

Button up pillowcases, close zip fasteners, hooks and poppers. Tie any belts or long tapes.

Remove persistent stains before washing.

Rub particularly soiled areas with a special detergent or detergent paste. Treat curtains with special care. Remove hooks or tie them up in a bag or a net.

## 6.4 Maximum Loads

Recommended loads are indicated in the program charts. General rules:

Cotton, linen:	drum full but not too tightly packed;
Synthetics, Delicate:	drum no more than half full;
woollens:	drum no more than one third full.

Washing a maximum load makes the most efficient use of water and energy. For heavily soiled laundry, reduce the load size.

## 6.5 Removing Stains

Stubborn stains may not be removed by just water and detergent. It is therefore advisable to treat them prior to washing.

**Blood:** treat fresh stains with cold water. For dried stains, soak overnight in water with a special detergent then rub in the soap and water.

**Oil based paint:** moisten with benzine stain remover, lay the garment on a soft cloth and dab the stain; treat several times.

**Dried grease stains:** moisten with turpentine, lay the garment on a soft surface and dab the stain with the fingertips and a cotton cloth.

**Rust:** oxalic acid dissolved in hot water or a rust removing product used in cold water. Be careful with rust stains which are not recent since the cellulose structure will already have been damaged and the fabric tends to hole.

**Mould stains:** treat with bleach, rinse well (whites and fast coloureds only).

**Grass:** soap lightly and treat with bleach (whites and fast coloureds only).

**Ball point pen and glue:** moisten with acetone (\*), lay the garment on a soft cloth and dab the stain.

**Lipstick:** moisten with acetone (\*) as above, then treat stains with methylated spirits. Remove any residual marks from white fabrics with bleach.

**Red wine:** soak in water and detergent, rinse and treat with acetic or citric acid, then rinse. Treat any residual marks with bleach.

**Ink:** depending on the type of ink, moisten the fabric first with acetone (\*), then with acetic acid; treat any residual marks on white fabrics with bleach and then rinse thoroughly.

**Tar stains:** first treat with stain remover, methylated spirits or benzine, then rub with detergent paste.

(\*) do not use acetone on artificial silk.

## 6.6 Detergents Type and Quantity of Detergent

**Low sudsing detergent is required for this washing machine to prevent oversudsing problems, unsatisfied washing result and harm to the machine.** Low sudsing detergents designed for front load washing machines are labelled “Front Loading”, “high efficiency”, “HE”, such as Cold Power for Front Loaders or “Matic”.

**Do not use wrong types of detergent,** such as Top Loading, Handwash detergent or Soap-Based products in your frontload washing machine. This can result in excessive suds, longer cycle time, low spin speeds, poor rinsing and overloading of the motor.

### Quantity of detergent to be used

The choice of detergent and use of correct quantities not only affects your washing performance, but helps to avoid waste and protect the environment.

Although biodegradable, detergents contain substances which, in large quantities, can upset the delicate balance of nature.

### **The choice and quantity of detergent will depend on ;**

- type of fabric (delicates, woollens, cottons, etc.) ;
- the colour of clothes ;
- size of the load ;
- degree of soiling ;
- washing temperature ; and
- hardness of the water used.

Water hardness is classified by so-called “degrees” of hardness.

Information on hardness of the water in your area can be obtained from the relevant water supply company, or from your local authority.

You may have to try using the detergent quantity as per the product manufacturers’ instructions then compare the washing result to the list below and adjust the amount of detergent for the next time accordingly.

### **Not enough washing powder causes:**

- the washload to turn grey,
- greasy clothes.

### **Too much washing powder causes:**

- sudsing,
- reduced washing effect,
- inadequate rinsing.

### **Use less detergent if:**

































- you are washing a small load,
- the laundry is lightly soiled,
- large amounts of foam during washing.

### **NOTE:**

- **Use only low sudsing front load type detergents and REDUCE the amount of detergent if oversudsing occurs.**

# 7. INTERNATIONAL WASH CODE SYMBOLS

**i** These symbols appear on fabric labels, in order to help you choose the best way to treat your laundry.

<b>Energetic wash</b> 	 Max. wash temperature 95 °C	 Max. wash temperature 60 °C	 Max. wash temperature 40 °C	 Max. wash temperature 30 °C	 Hand wash	 DO NOT wash at all
<b>Delicate wash</b> 			 			
<b>Bleaching</b> 	 Bleach in cold water			 DO NOT bleach		
<b>Ironing</b> 	 Hot iron max. 200 °C	 Warm iron max. 150 °C	 Lukewarm iron max. 110 °C	 DO NOT iron		
<b>Dry cleaning</b> 	 Dry cleaning in all solvents	 Dry cleaning in perchlorethylene, petrol, pure alcohol, R 111 & R 113		 Dry cleaning in petrol, pure alcohol and R 113		 DO NOT dry clean
<b>Drying</b> 	 Flat	 On the line	 On clothes hanger	 High temperature  Low temperature Tumble dry	 DO NOT tumble dry	

## 8. CARE AND CLEANING



### **WARNING!**

You must **DISCONNECT** the appliance from the electricity supply, before you can carry out any cleaning or maintenance work.

### 8.1 External Cleaning

Clean the appliance only with soap and warm water. Fully dry all the surfaces.



### **CAUTION!**

**Do not use alcohol, solvents or chemical products.**

### 8.2 Descaling

The water we use normally contains lime. It is a good idea to periodically use a water softening powder in the machine.

Do this separately from any laundry washing, and according to the softening powder manufacturer's instructions.

This will help to prevent the formation of lime deposits.

### 8.3 After Each Wash

Leave the door open for a while. This helps to prevent mould and stagnant smells forming inside the appliance. Keeping the door open after a wash will also help to preserve the door seal.

### 8.4 Maintenance Wash

With the use of low temperature washes it is possible to get a build up of residues inside the drum.

We recommend that a maintenance wash be performed on a regular basis.

To run a maintenance wash:

- The drum should be empty of laundry.
- Select the hottest wash program.
- Use a normal measure of detergent, must be a powder with biological properties.
- **Press Start/Pause to start the program.**

### 8.5 Cleaning The Dispenser Drawer

The washing powder and additive dispenser drawer should be cleaned regularly. Remove the drawer by pushing the catch and pulling it out. Flush it out under a tap, to remove any traces of accumulated powder.

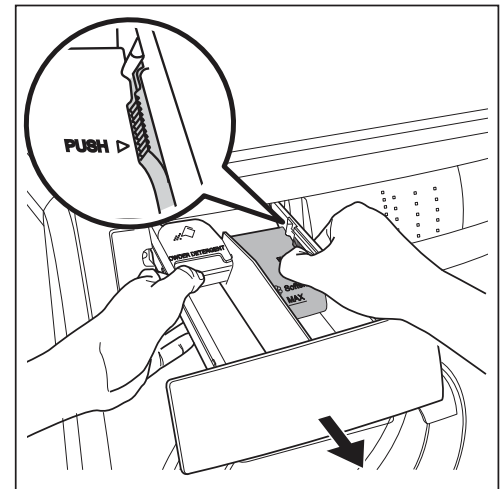

To aid cleaning, the top part of the additive compartment should be removed.

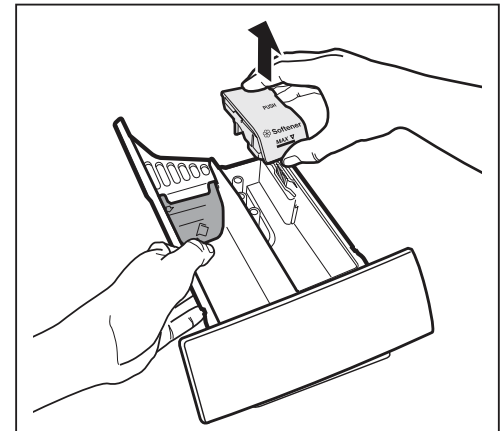



## 8.6 Cleaning The Drawer Bottom

After washing cycle finish, residues of softener and water may remain in the softener dispenser. It is recommended to clean the bottom of softener dispenser regularly to remove any residue.

To clean the bottom of softener dispenser:

1. After pulling out the drawer from its recess, turn the bottom side up.

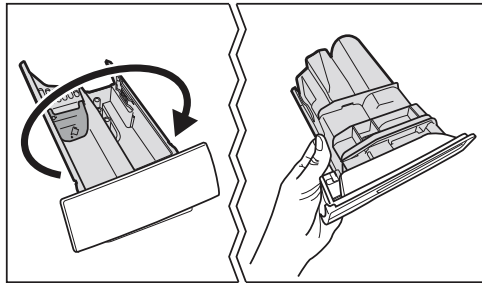

2. Push the catch and pull up the softener bottom cover.

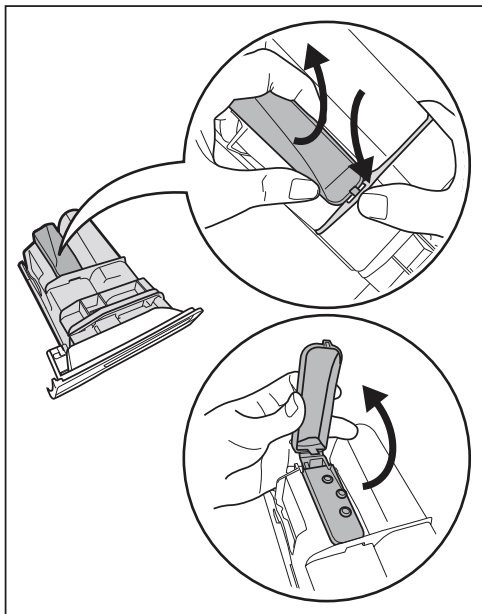

3. Clean the dispenser with an old toothbrush under the water tap.

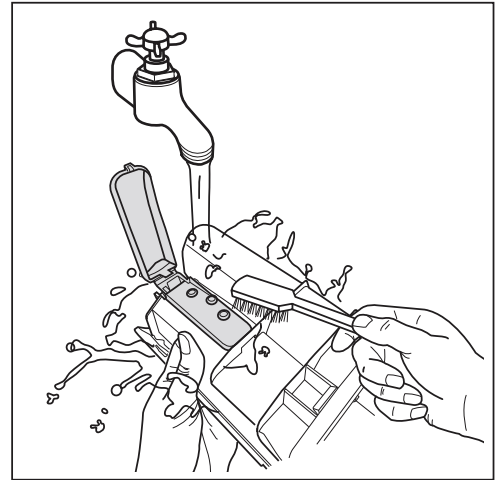

4. Close the softener bottom cover.

## 8.7 Cleaning The Drawer Recess

Having removed the drawer, use a small brush to clean the recess, ensuring that all washing powder residue is removed from the upper and lower part of the recess. Replace the drawer and run the rinse program without any clothes in the drum.

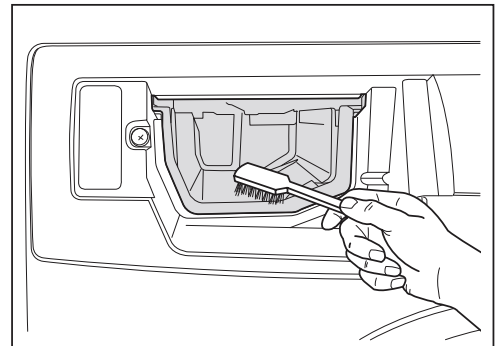

## 8.8 Cleaning The Water Inlet Filter

If your water is very hard or contains traces of lime deposit, the water inlet filter may become clogged.

It is therefore a good idea to clean it from time to time.

To clean the water inlet filters:

1. Close the water tap.
2. Remove the water inlet hose from the water tap.
3. Clean the filter in the inlet hose with a stiff brush.
4. Remove the inlet hose behind the appliance.
5. Clean the filter in the valve with a stiff brush or a towel.

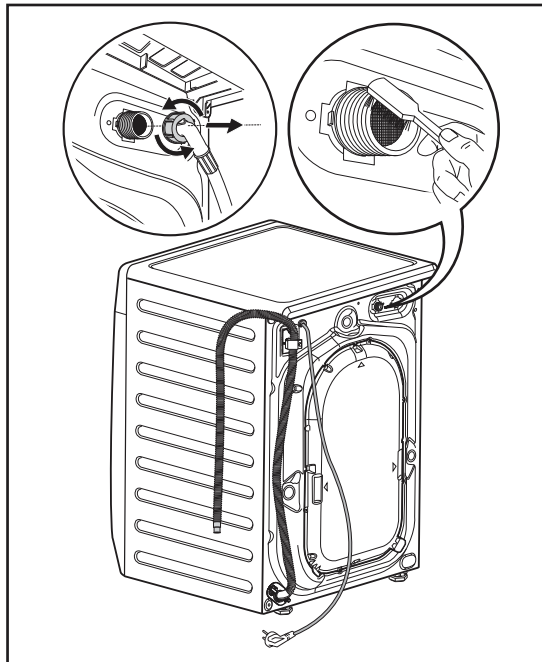
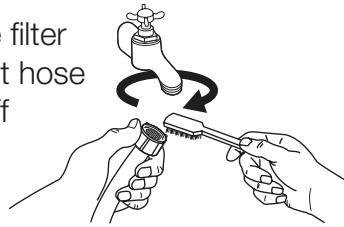

6. Install again the inlet hose. Make sure that the couplings are tight to prevent leakages.

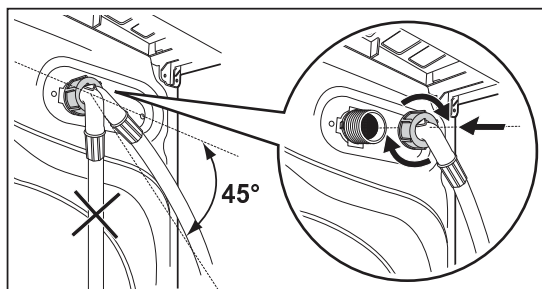

7. Open the water tap.

## 8.9 The Dangers Of Freezing

If the machine is exposed to temperatures below 0°C, certain precautions should be taken.



Do this procedure also when you want to do the emergency drain.



**Disconnect the mains plug from the mains socket.**

1. Turn off the water tap.
2. Unscrew the inlet hose.
3. Remove the drain hose from the rear support and unhook it from sink or spigot.

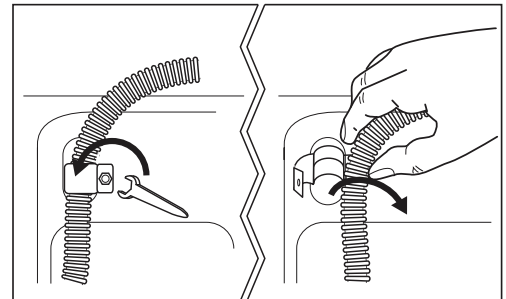

4. Put the ends of the drain and inlet hose in a container. Let the water flow out of the hoses.
5. When no more water flows, install the inlet hose and the drain hose again.



**Make sure that the temperature is more than 0 °C before you use the appliance again.**

**The manufacturer is not responsible for damages caused by low temperatures.**

## 9. TROUBLESHOOTING

Certain problems are due to lack of simple maintenance or oversights, which can be solved easily without calling out an engineer.

Before contacting your local Service Centre, please carry out the checks listed below. During machine operation it is possible that the red Start/Pause pilot light flashes to indicate that the machine is not working.

Once the problem has been eliminated, press the Start/Pause touchpad to restart the program. If after all checks, the problem persists, contact your local Service Centre.

 **WARNING! Deactivate the appliance before you do the checks.**

**With some problems, the acoustic signals operate and the display shows an alarm code:**

<b>E10</b>	The appliance does not fill with water properly.
<b>E20</b>	The appliance does not drain the water.
<b>E40</b>	The appliance door is open or not closed correctly. Please check the door!
<b>E40</b>	The mains supply is unstable. Wait until the mains supply is stable.
<b>E91</b>	No communication between electronic elements of the appliance. Switch off and switch on again.

### Possible failures

Malfunction	Possible cause => Solution
<b>The washing machine does not start:</b>	The door has not been closed. (Error code: E40) => Close the door firmly.
	The plug is not properly inserted in the power socket. => Insert the plug into the power socket.
	There is no power at the socket. => Please check your domestic electrical installation.
	The Start/Pause touchpad has not been pressed. => Press the Start/Pause touchpad.
	The "Delay End" has been selected. => If the laundry are to be washed immediately, cancel the "Delay End".
	The main supply is unstable. (If E40 appears in the display.) => Wait until the main supply is stable and the appliance automatically starts operating.
<b>The machine does not fill the water:</b>	The water tap is closed. (Error code: E10) => Open the water tap.
	The inlet hose is squashed or kinked. (Error code: E10) => Check the inlet hose connection.
	The filter in the inlet hose is blocked. (Error code: E10) => Clean the water inlet hose filter.
	The door is not properly closed. (Error code: E40) => Close the door firmly.
<b>The machine fills then empties immediately:</b>	The end of the drain hose is too low. (Error code: E10) => Refer to relevant paragraph in "water drainage" section.

Malfunction	Possible cause => Solution
<b>The machine does not empty and/or does not spin:</b>	The drain hose is squashed or kinked. (Error code: E20 ) => Check the drain hose connection.
	The drain pump is clogged. (Error code: E20 ) => Please call Service Center.
	The option "Rinse Hold" or "No Spin" has been selected. => Press Start/Pause to drain the water. (see page 17) or select spin program.
	The laundry is not evenly distributed in the drum. => Pause the machine and redistribute laundry manually.
<b>There is water on the floor:</b>	Too much detergent or unsuitable detergent (creates too much foam) has been used. => Reduce the detergent quantity or use another one.
	Check whether there are any leaks from one of the inlet hose fittings. It is not always easy to see this as the water runs down the hose; check to see if it is damp. => Check the water inlet hose connection.
	The drain hose is damaged. => Change it with a new one.
<b>Unsatisfactory washing results:</b>	Too little detergent or unsuitable detergent has been used. => Increase the detergent quantity or use another one.
	Stubborn stains have not been treated prior to washing. => Use commercial products to treat the stubborn stains.
	The correct temperature was not selected. => Check if you have selected the correct temperature.
	Excessive laundry load. => Reduce load.
<b>The door will not open:</b>	The program is still running. => Wait until the end of washing cycle.
	There is water in the drum. => Select "Drain & Spin" option to empty out the water.
	In case of power failed, the door cannot be open. => Please wait until the power resume. But, if you really need to open it, please call Service Center.
<b>The machine vibrates or is noisy:</b>	The transit bolts and packing have not been removed. => Check the correct installation of the appliance.
	The support feet have not been adjusted. => Check the correct levelling of the appliance.
	The laundry is not evenly distributed in the drum. => Pause the machine and redistribute laundry manually.
	There is very little laundry in the drum. => Load more laundry.
	Unstable floors eg. wooden floors. => Refer to relevant paragraph in "Positioning" section.
<b>Cycle time longer than displayed:</b>	Detergent over dose. => Reduce the detergent quantity or use another one.
	Machine unbalance. => Redistribute laundry manually in the drum and start the spin phase again. Refer to relevant paragraph in "Positioning" section.
<b>There is water on the floor:</b>	Too much detergent or unsuitable detergent (creates too much foam) has been used. => Reduce the detergent quantity or use another one.
	Check whether there are any leaks from one of the inlet hose fittings. It is not always easy to see this as the water runs down the hose; check to see if it is damp. => Check the water inlet hose connection.
	The drain hose is damaged. => Change it with a new one.

Malfunction	Possible cause => Solution
<b>Unsatisfactory washing results:</b>	Too little detergent or unsuitable detergent has been used. => Increase the detergent quantity or use another one.
	Stubborn stains have not been treated prior to washing. => Use commercial products to treat the stubborn stains.
	The correct temperature was not selected. => Check if you have selected the correct temperature.
	Excessive laundry load. => Reduce load.
<b>The door will not open:</b>	The program is still running. => Wait until the end of washing cycle.
	There is water in the drum. => Select "Drain & Spin" option to empty out the water.
	In case of power failed, the door cannot be open. => Please wait until the power resume. But, if you really need to open it, please call Service Center.
<b>The machine vibrates or is noisy:</b>	The transit bolts and packing have not been removed. => Check the correct installation of the appliance.
	The support feet have not been adjusted. => Check the correct levelling of the appliance.
	The laundry is not evenly distributed in the drum. => Pause the machine and redistribute laundry manually.
	There is very little laundry in the drum. => Load more laundry.
	Unstable floors eg. wooden floors. => Refer to relevant paragraph in "Positioning" section.
<b>Cycle time longer than displayed:</b>	Detergent over dose. => Reduce the detergent quantity or use another one.
	Machine unbalance. => Redistribute laundry manually in the drum and start the spin phase again. Refer to relevant paragraph in "Positioning" section.
<b>The cycle is shorter than the time displayed.</b>	The appliance calculates a new time according to the laundry load.
<b>Spinning starts late or the machine does not spin:</b>	The electronic unbalance detection device has cut in because the laundry is not evenly distributed in the drum. The laundry is redistributed by reverse rotation of the drum. This may happen several times before the unbalance disappears and normal spinning can resume. If, after 10 minutes, the laundry is still not evenly distributed in the drum, the machine will not spin. In this case, redistribute the load manually and select the spin program. => Pause the machine and redistribute laundry manually.
<b>No water is visible in the drum:</b>	Machines based on modern technology operate very economically using very little water without affecting performance.



If you are unable to identify or solve the problem, contact our service centre. Before telephoning, make a note of the model, serial number and purchase date of your machine: the Service Centre will require this information.

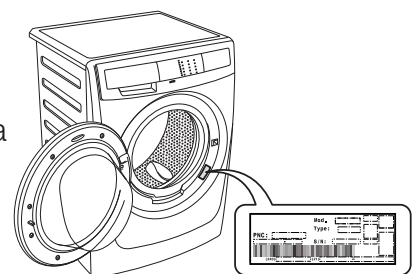

## 10. TECHNICAL DATA

<b>Dimensions</b> (H x W x D)	85 x 60 x 56.8 cm		
<b>Power supply</b> (Voltage / Frequency)	220 V / 60 Hz		
<b>Total power absorbed</b>	1700 W		
<b>Minimum fuse protection</b>	10 A		
<b>Water supply pressure</b> (Maximum / Minimum)	0.8 MPa / 0.05 MPa		
<b>Maximum dry clothes capacity</b>	Program:	Model	Model
		EWF12844:	EWF10744:
	Cottons	8 Kg	7.5 Kg
	Mixed	4 Kg	3.5 Kg
	Quick 20	1.5 Kg	1 Kg
	Bedding	4 Kg	3.5 Kg
	Delicates	4 Kg	3.5 Kg
	Wool/Handwash	2.5 Kg	2 Kg
	Baby Wear	4 Kg	3.5 Kg
	Energy Saving	8 Kg	7.5 Kg
<b>Spin speed</b> (Maximum / Minimum)	Model: EWF12844 = 1200 rpm / 800 rpm Models: EWF10744 = 1000 rpm / 600 rpm		

## 11. INSTALLATION

### 11.1 Unpacking

#### **!** CAUTION!

**All transit bolts and packing must be removed before using the appliance.**

You are advised to keep all transit devices so that they can be refitted if the machine ever has to be transported again.

1. Cut and remove four cut out straps as shown.

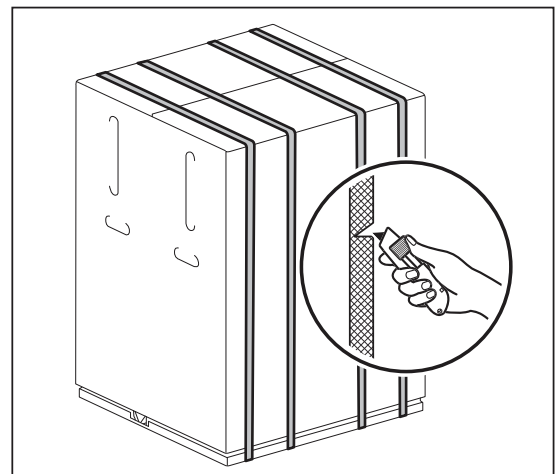



2. Open top flaps and remove internal foam inserts as shown on picture.

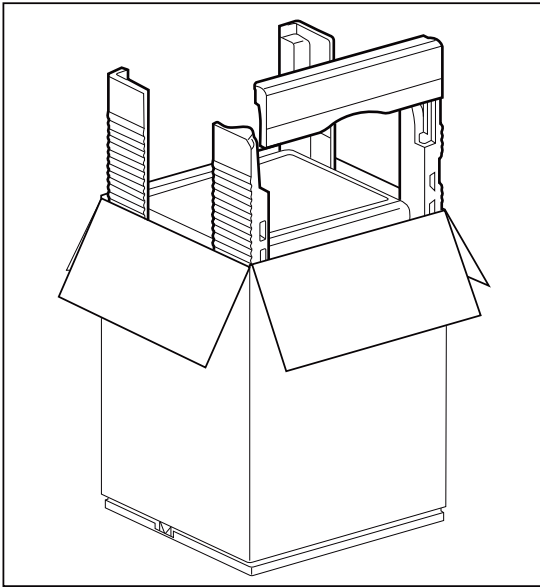

3. Remove the carton box and plastic bag which cover the machine as indicated on picture.

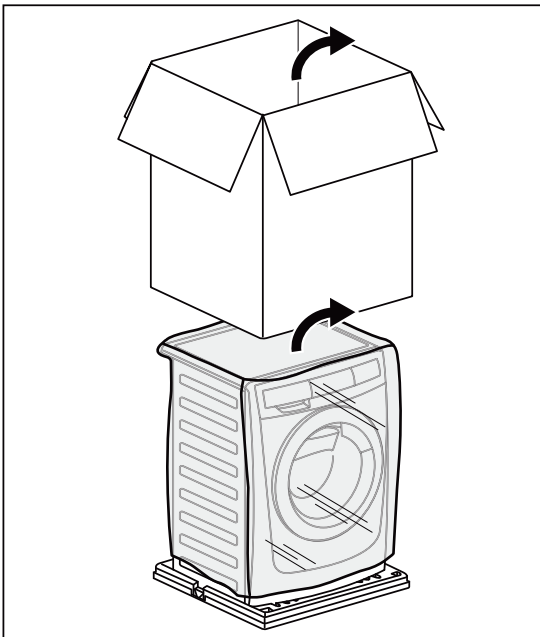

4. Open the door. Remove all the items from the drum.

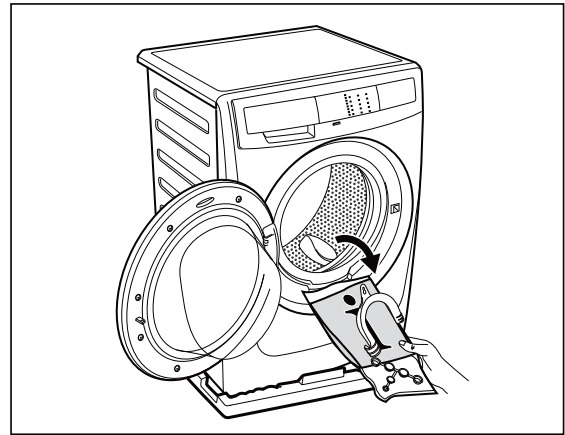

5. Put one of the polystyrene packaging elements on the floor behind the appliance. Carefully put down the appliance with the rear side on it. Make sure not to damage the hoses.

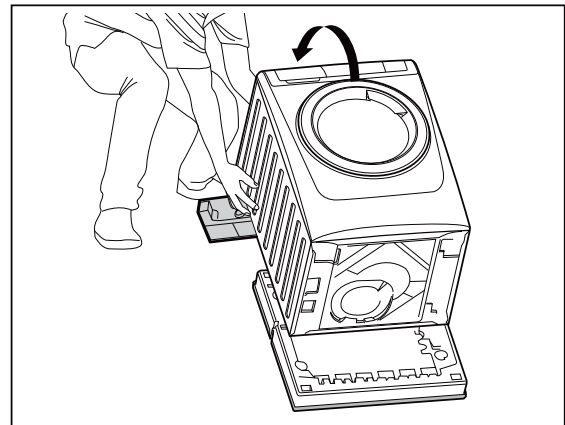

6. Remove the polystyrene base.

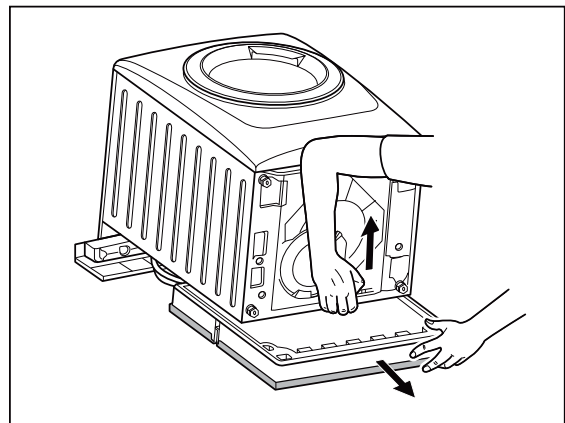



7. Pull up the appliance in vertical position.
8. Remove the power supply cable and the drain and inlet hoses from the hose holders (A) on the rear of the appliance.

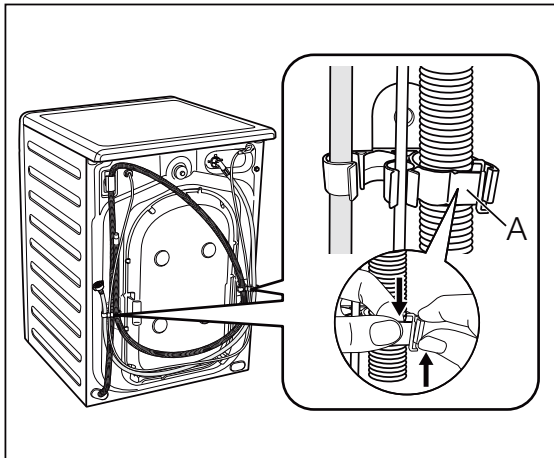

9. Remove the three bolts.
10. Pull out the plastic spacers.

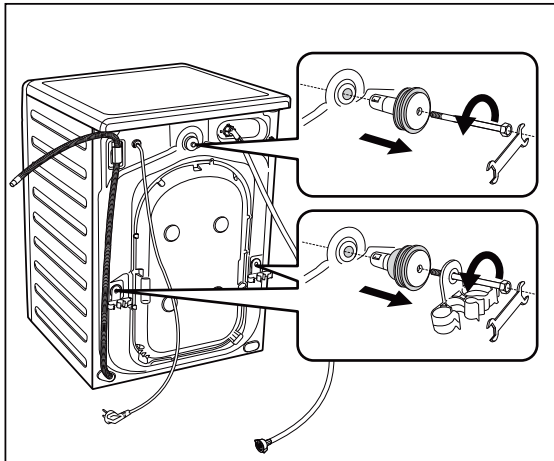

11. Put the plastic caps in the holes. You can find these caps in the user manual bag.

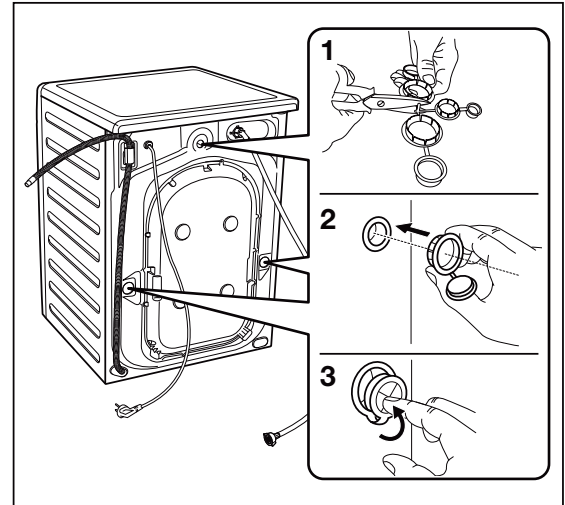

## 11.2 Positioning

### **i** IMPORTANT

**It is important that your washing machine stands firm and level on the floor to ensure correct operation.**

The appliance must not be installed behind a lockable door, a sliding door or a door with a hinge on the opposite side so that the washing machine door is restricted.

Use a spirit level on the top and side of the washing machine to check the levels.

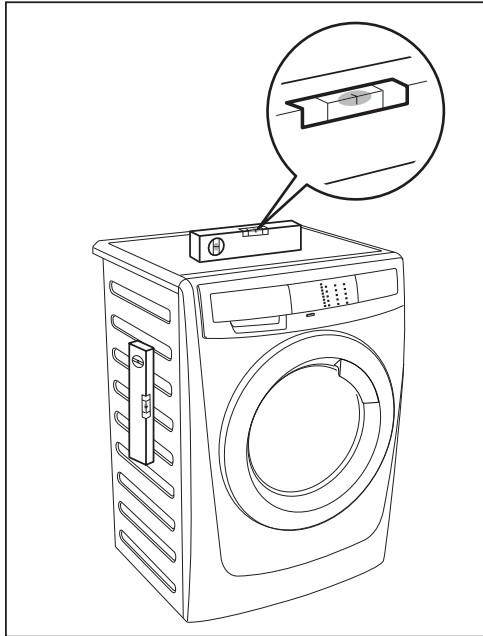

If you do not have a spirit level, as a guide use the edge of a door frame, cupboard or bench to check that the washing machine is level.

Loosen or tighten the feet to adjust the level. A correct adjustment of the appliance level prevents the vibration, noise and the movement of the appliance when in operation.

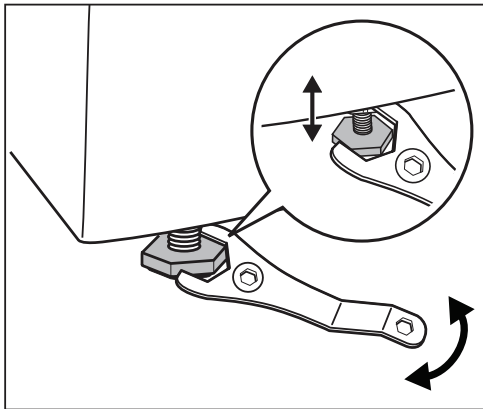

When the washing machine is levelled, try to rock it from corner to corner. If it does rock, adjust the legs again until it is levelled and does not rock.

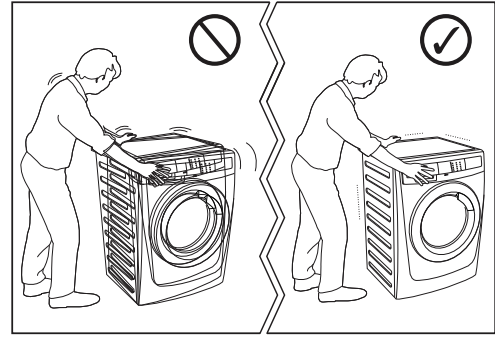

Never place cardboard, wood or similar materials under the machine to compensate for any unevenness in the floor.

Install the machine on a flat hard floor. Make sure that air circulation around the machine is not impeded by carpets, rugs etc.

Check that the machine does not touch the wall or cupboard units.

### 11.3 Water Inlet

Connect the water inlet hose to a tap with 3/4" BSP thread.

Use the hose supplied with the washing machine. **DO NOT USE OLD HOSES.**

The other end of the inlet hose which connects to the machine can be turned in any direction.

Simply loosen the fitting, rotate the hose and retighten the fitting, making sure there are no water leaks.

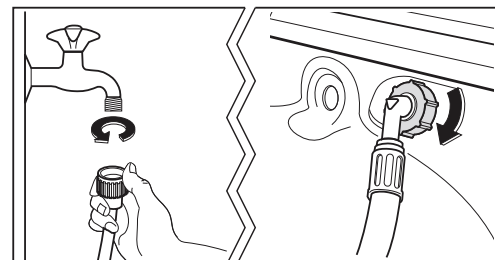

The inlet hose must not be lengthened. If it is too short and you do not wish to move the tap, you will have to purchase a new, longer hose specially designed for this type of use.

### 11.4 Water Drainage

The end of the drain hose can be positioned in three ways:

- Hooked over the edge of a sink using the plastic hose guide supplied with the machine.

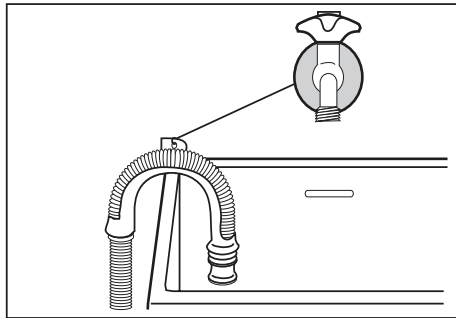

In this case, make sure the end cannot come unhooked when the machine is emptying.

This could be done by tying it to the tap with a piece of string or attaching it to the wall.

- In a sink drain pipe branch. This branch must be above the trap so that the bend is at least 60 cm above the ground.
- Directly into a drain pipe at a height of no less than 60 cm and no more than 90 cm. The end of the drain hose must always be ventilated, i.e. the inside diameter of the drain pipe must be larger than the outside diameter of the drain hose.

The drain hose must not be kinked. Run it along the floor, only the part near the drainage point must be raised.

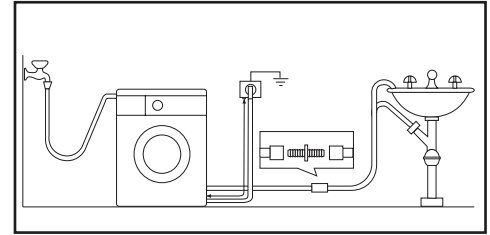

For correct functioning of the machine the drain hose must remain hooked on the proper support piece situated on the top part of back side of the appliance.

### 11.5 Electrical Connection

This machine is designed to operate on a 220 V, single-phase, 60 Hz supply.

**! Please check rated power supply condition that is mentioned on the Rating Label before you connect to the power supply.**

**“An incorrect power supply may void your warranty.”**

Check that your domestic electrical installation can take the maximum load required (1.7 kW), also taking into account any other appliances in use.

**! Connect the machine to an earthed socket outlet.**

The manufacturer declines any responsibility for damage or injury through failure to comply with the above safety precaution.

**! If the supply cord is damaged, should the appliance power supply cable need to be replaced, this shall be carried out by our Service Centre.**

When the appliance is installed the power supply cable must be easily accessible.

If this appliance is supplied from a cord extension set or electrical portable outlet device, the cord extension set or electrical portable device must be positioned so that it is not subject to splashing or ingress of moisture.

## 12. ENVIRONMENT CONCERNS

### 12.1 Packaging Materials



The materials marked with the symbol  are recyclable.

>PE<=polyethylene  
>PS<=polystyrene  
>PP<=polypropylene

This means that they can be recycled by disposing of them properly in appropriate collection containers.

### 12.2 Old Machine

Use authorised disposal sites for your old appliance. Help to keep your country tidy!



The symbol  on the product or on its packaging indicates that this product may not be treated as household waste. Instead it shall be handed over to the applicable collection point for the recycling of electrical and electronic equipment.

By ensuring this product is disposed of correctly, you will help prevent potential negative consequences for the environment and human health, which could otherwise be caused by inappropriate waste handling of this product.

For more detailed information about recycling of this product, please contact your local city office, your household waste disposal service or the shop where you purchased the product.

### 12.3 Ecological Hints

To save water, energy and to help protect the environment, we recommend that you follow these tips:

- Normally soiled laundry may be washed without prewashing in order to save detergent, water and time (the environment is protected too!).
- The machine works more economically if it is fully loaded.
- With adequate pre-treatment, stains and limited soiling can be removed; the laundry can then be washed at a lower temperature.
- Measure out detergent according to the water hardness, the degree of soiling and the quantity of laundry being washed.

NOTE



www.electrolux.com



G0009552-001-A00973056-342015

