

# INSTALLATION



**WARNING!**  
Refer to Safety chapters.

## 1 Location of the appliance

You can install your freestanding appliance with cabinets on one or two sides and in the corner.



Keep a distance of about 1 cm between the appliance and the back wall to make sure that the lid opens.

For minimal distances for fitting check the table.

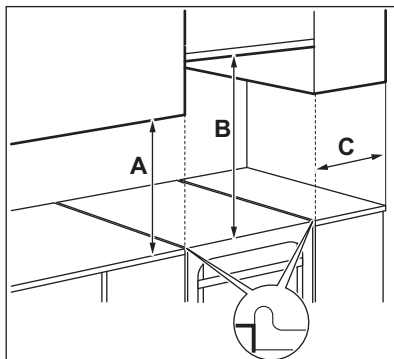

## Minimum distances

Dimension	mm
A	400
B	650
C	150

## 2 Technical data

Voltage	220 - 240 V
---------	-------------

Frequency	50 / 60 Hz
Appliance class	1

Dimension	mm
Height	855
Width	600
Depth	600

## 3 Other technical data

Appliance category:	I3B/P
Gas original:	G30 30 mbar

## 4 Bypass diameters

BURNER	Ø BYPASS <sup>1)</sup> 1/100 mm
Auxiliary	29 / 30
Semi-rapid	32
Triple Crown	67

1) Type of bypass depends on model.

## 5 Gas burners for LPG G30 30 mbar

BURNER	NORMAL POWER kW	REDUCED POWER kW	INJECTOR MARK 1/100 mm	NOMINAL GAS FLOW g/h
Triple Crown	4.0	1.80	101	291
Semi-rapid	2.0	0.43	71	145
Auxiliary	1.0	0.35	50	73

## 6 Gas connection

Use a fixed connections or use a flexible stainless steel pipes in compliance with the regulation in force. If you use flexible metallic pipes, make sure they do not come in touch with mobile parts and they are not squeezed.

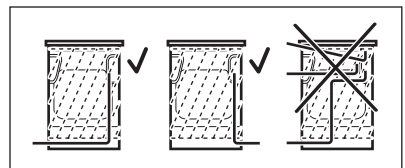

**WARNING!**

The gas connection pipe must not touch the part of the appliance shown in the illustration.

## 7 Flexible nonmetal pipes connection

If you have an easy access to the connection, you can use a flexible pipe. The flexible pipe must be tightly attached by clamps.

In installation always use the pipe holder and the gasket. The flexible pipe can be applied when:

- it can not get hotter than room temperature, higher than 30 °C,
- it is not longer than 1500 mm,
- it has no narrowing anywhere,
- it is not twisted or tighten,
- it does not get in touch with sharp edges or corners,
- it's conditions can be easily checked.

When checking the flexible pipe make sure:

- it does not show cracks, cuts, marks of burnings on the two ends and on its full length,
- the material is not hardened, but shows its correct elasticity,
- the fastening clamps are not rusted,
- expired term is not due.

If one or more defects are visible, do not repair the pipe, but replace it.

**WARNING!**

When installation is complete, make sure that the seal of each pipe fitting does not leak. To check the seal use a soap solution, not a flame.

The gas supply ramp is on the rear side of the control panel.

**WARNING!**

Before you connect the gas, disconnect the appliance from the electricity supply or switch off the fuse in the fuse box. Close the primary valve of the gas supply.

## 8 Connection to gas supply

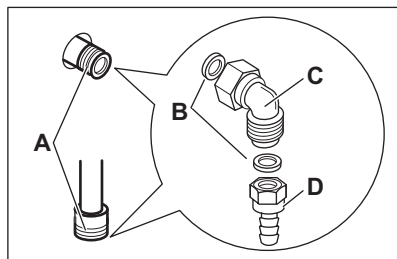

- A. Gas connection point (only one point is applicable for the appliance)  
 B. Gasket  
 C. Adjustable connection  
 D. LPG pipe holder

## 9 Levelling of the appliance

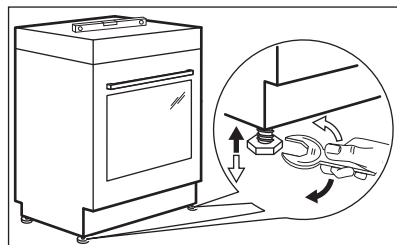

Use small feet on the bottom of appliance to set the appliance top surface level with other surfaces.

## 10 Anti-tilt protection

Set the correct height and area for the appliance before you attach the anti-tilt protection.

**CAUTION!**

Make sure you install the anti-tilt protection at the correct height.



Make sure that the surface behind the appliance is smooth.

You must install the anti-tilt protection. If you do not install it, the appliance can tilt.

Your appliance has the symbol shown on the picture (if applicable) to remind you

about the installation of the anti-tilt protection.

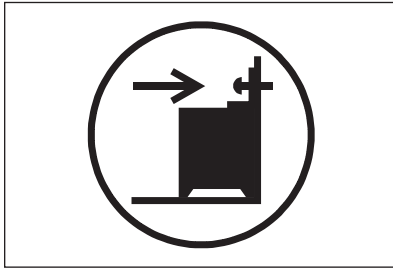

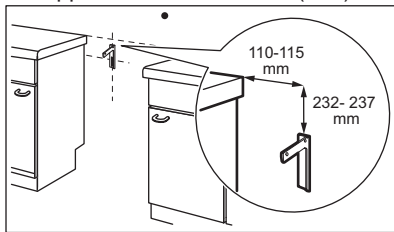

1. Install the anti-tilt protection 232 - 237 mm down from the top surface of the appliance and 110 - 115 mm from the side of the appliance into the circular hole on a bracket. Screw it into the solid material or use applicable reinforcement (wall).



2. You can find the hole on the left side at the back of the appliance. Lift the front of the appliance and put it in the

middle of the space between the cupboards. If the space between the bench cupboards is larger than the width of the appliance, you must adjust the side measurement to centre the appliance.

-  If you changed the dimensions of the cooker, you must align the non-tip device correctly.

 **CAUTION!** If the space between the bench cupboards is larger than the width of the appliance, you must adjust the side measurement to the centre of the appliance.

## 11 Electrical installation

 **WARNING!** The manufacturer is not responsible if you do not follow the safety precautions from Safety chapters.

This appliance is supplied with a main plug and a main cable.

 **WARNING!** The power cable must not touch the part of the appliance shaded in the illustration.

